

JAMES MILLEN

MANUFACTURING COMPANY, INC.

*Manufacturers of Grid Dip Meters, Amateur Radio Equipment, Module Oscilloscopes,
Magnetic Shields, Delay Lines In Addition To Millen Components.*



150 EXCHANGE STREET • MALDEN, MASSACHUSETTS 02148, U.S.A.

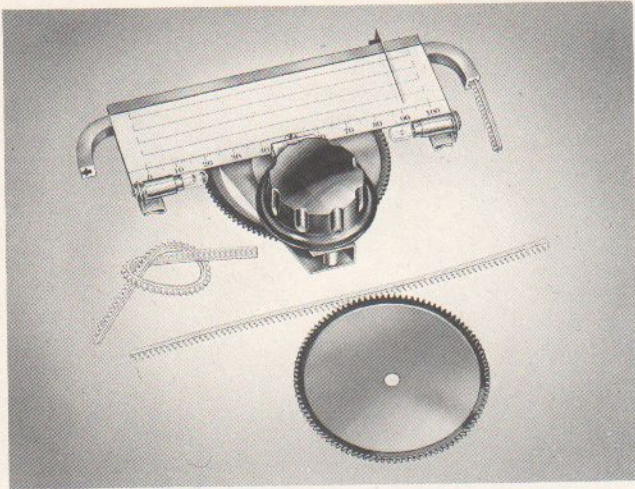

NO.10037 NO-STRING ILLUMINATED DIAL
Reduction 11:1 Scale Length 6 1/2"

The 10037 is a mechanically engineered dial which completely eliminates the annoyances of string-driven pointers, and provides positive pointer travel and resetability. The pointer is driven positively by a flexible rack which cannot slip. The flexible rack rides in an extruded aluminum channel. This girder-like piece provides rigidity. The drive mechanism is a smooth friction drive with 180° rotation of the output shaft. Teflon bearings assure a lifetime of smooth operation. 5 1/2 turns of the knob results in 6 1/2" of pointer travel. The dial has a convenient adjustable zero-set and an anti-parallax pointer. The dial is supplied with a bezel for the front of the panel. Outside dimensions of the bezel are 7 5/8" w x 2 5/8" h. The behind-the-panel space required is 9" w x 5 3/4" h x 1 1/4" d overall.



10035

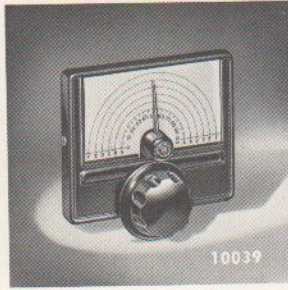

10039

PANEL DIALS — The No. 10035 illuminated panel dial has 12 to 1 ratio; size, 8 1/2" x 6 1/2". Small No. 10039 has 8 to 1 ratio; size, 4" x 3 1/4". Both are of compact mechanical design, easy to mount and have totally self-contained mechanism, thus eliminating back of panel interference. Standard finish, either size, flat black art metal.

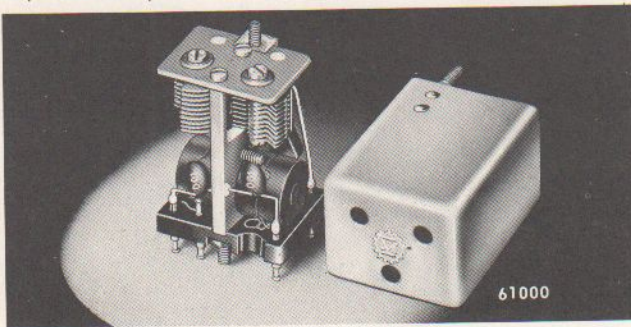

61000

MINIATURE IF TRANSFORMERS — Extremely high Q — approximately 200 — Variable Coupling — (under, critical, and over) with all adjustments on top. Small size 1 1/8" x 1 7/8" x 1 7/8" Molded terminal base. Air capacitor tuned. Coils completely enclosed in cup cores. Tapped primary and secondary. Rugged construction. High electrical stability.

- No. 61455, 455 kc. Universal Trans.....
- No. 61160, 1600 kc. Universal Trans.....

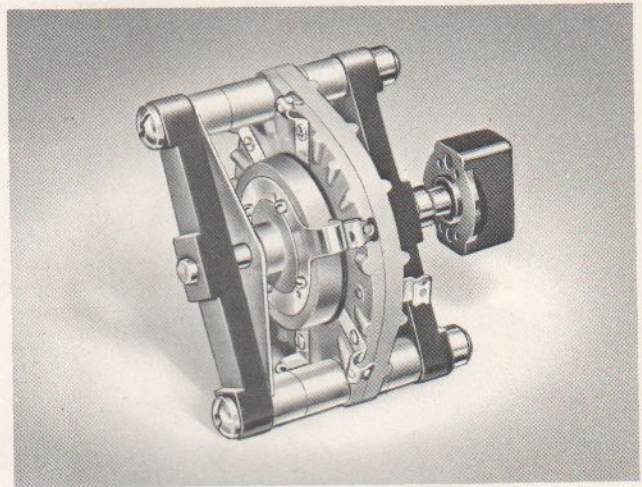

51000 HIGH VOLTAGE R-F SWITCHES

- 51001 — Single Wafer — 1 pole, 2 to 6 positions
13 KV. D.C. Flashover
20 Amperes
- 51001D — Single Wafer — 2 poles
2 or 3 positions
9 KV. D.C. Flashover
20 Amperes
- 51002 — Double Wafer — 2 poles
2 to 6 positions
13 KV. D.C. Flashover
20 Amperes
- 51002D — Double Wafer — 4 poles
2 or 3 positions
9 KV. D.C. Flashover
20 Amperes

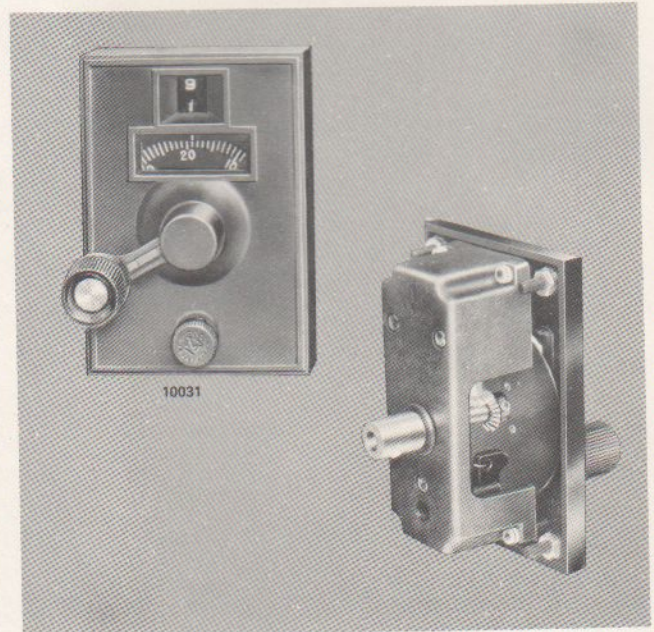

10031

10031 COUNTER DIAL

The No. 10031 Dial is a rugged turns counter dial. It has a 0-99 turn digital readout plus a vernier scale calibrated 0-100. The design includes a built-in dial lock. As shown below, the output coupling is a hub for 1/4" diameter shaft. The crank handle drives any multiturn device directly. This new small size dial is designed to drive vacuum variable capacitors, rotary tunable inductors, multi-turn potentiometers, permeability tuned inductors and other multi-turn devices.



MILLEN TUBE SOCKETS DESIGNED FOR APPLICATION

Long Flashover path to chassis permits use with transmitting tubes, 866 rectifiers, etc. Long leakage path between contacts. Contacts are type proven by hundreds of millions already in government, commercial and broadcast service, to be extremely dependable. Sockets may be mounted either with or without metal flange. Mounts in standard size chassis hole. All types have barrier between contacts and chassis. All but octal and crystal sockets also have barriers between individual contacts in addition.

Voltage regulator dual contact bayonet socket, 33991 black phenolic insulation and 33992 with low loss mica filled phenolic insulation.

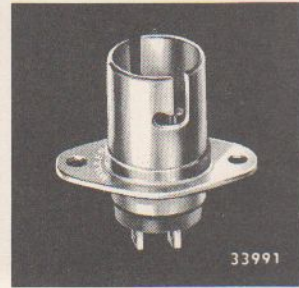
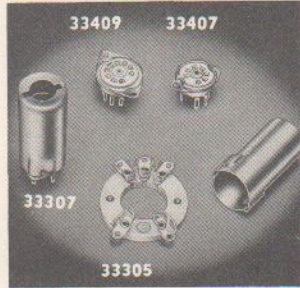
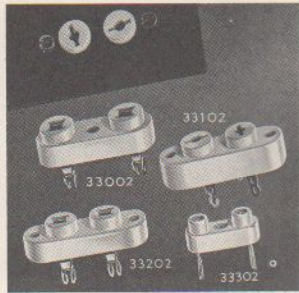

MILLEN TUBE SOCKETS

No.	Description	No.	Description
33002	Crystal Socket $\frac{3}{4}$ " x .125"	33004	4 Pin Tube Socket
33102	Crystal Socket .487" x .095"	33005	5 Pin Tube Socket
33202	Crystal Socket $\frac{1}{2}$ " x .125"		
33302	Crystal Socket .487" x .050"	33008	8 Pin Tube Socket
33407	Miniature Socket only, ceramic	33991	Socket for 991.....
33409	Noval Socket only, ceramic	33992	Socket for 991.....
33307	Miniature Socket, Shield, ceramic		
33309	Noval Socket, Shield, ceramic	33305	Acorn Socket.....

FLEXIBLE COUPLINGS — The No. 39000 series of Millen "Designed for Application" flexible coupling units include, in addition to improved versions of the conventional types, also such exclusive original designs as the No. 39001 insulated universal joint and the No. 39006 "slide-action" coupling (in both steatite and bakelite insulation). The No. 39006 "slide-action" coupling permits longitudinal shaft motion, eccentric shaft motion and out-of-line operation, as well as angular drive.

The No. 39005 and 39005-B (high torque) are similar to the No. 39001, but are not insulated. The steatite insulated No. 39001 has a special anti-backlash pivot and socket grip feature. All of the above illustrated units are for $\frac{1}{4}$ " shaft and are standard production type units.

The No. 39016 incorporates features which have long been desired in a flexible coupling. No Backlash — High Flexibility — Higher Breakdown Voltage — Smaller Diameter — Shorter Length —

CERAMIC PLATE OR GRID CAPS — Soldering lugs and contact one-piece. Lug ears annealed and solder dipped to facilitate "mechanical plus soldered" connection of cable.

No. 36001— $\frac{7}{16}$ " No. 36002— $\frac{3}{8}$ " No. 36004— $\frac{1}{4}$ "

SAFETY TERMINAL — Combination high voltage terminal and thru-bushing. Tapered contact pin fits firmly into conical socket providing large area, low resistance connection. Pin is swivel mounted in cap to prevent twisting of lead wire.

No. 37001, Black or Red No. 37501, Low loss

STEATITE TERMINAL STRIPS — Terminal and lug are one piece. Lugs are turret type and are free floating so as not to strain L522 ceramic on wide temperature variations. Easy to mount with series of round holes. 1400 volt and 3500 volt series.

POSTS, PLATES, AND PLUGS — The No. 37200 series, including both insulated and non-insulated binding posts with associated plates and plugs, provide various combinations to meet most requirements. The posts have captive heads and keyed mounting. The No. 37291 on No. 37223 are standard in black or red with other colors on special order. No. 37201, No. 37202, and No. 37204 are available in black, red, or low loss. The No. 37202 is also available in steatite.

No.	Description	No.	Description
37201	Single plates, pr.	37212	Dual plug
37291	Single plates	37222	Non-insulated binding post (tapered), pr.
37202	Dual plates, pr.	37223	Insulated binding post

DIAL LOCK — Compact, easy to mount, positive in action, does not alter dial setting in operation! Rotation of knob "A" depresses finger "B" and "C" without imparting any rotary motion to Dial. Single hole mounted.

No. 10050

TUBE CLAMP — No. 33087 is easy to use, easy to install, effective in function. Available in special sizes for all types of tubes. Single hole mounting. Spring steel, cadmium plated.

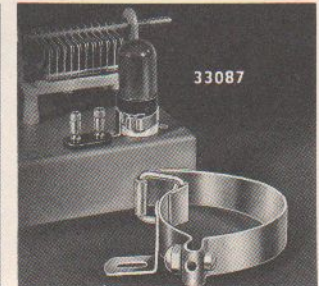
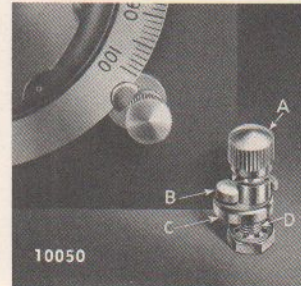
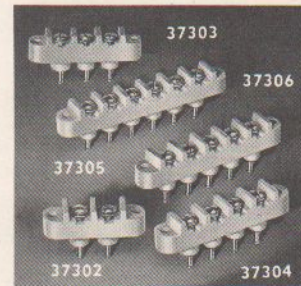
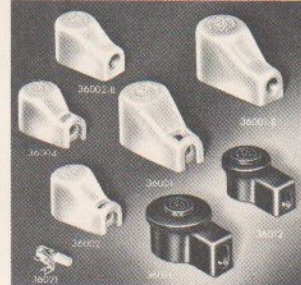
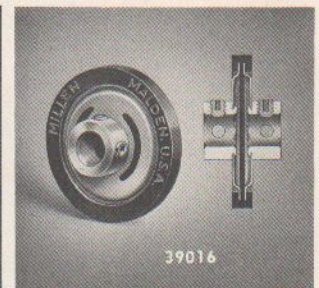
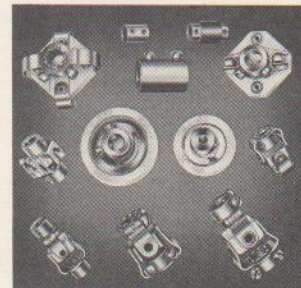



34300 SERIES INDUCTORS

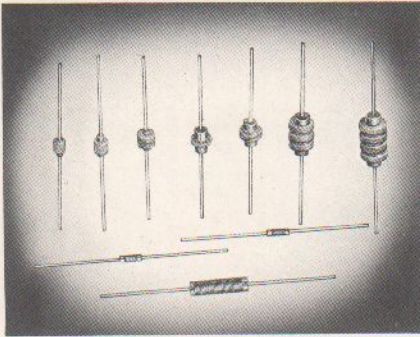

Part	Inductance Microhenries	Self Resonant Freq. Mc.	Fig. No.
34300-0.15	0.15 ± 10%	645 MC.	1
34300-0.22	0.22 ± 10%	510	1
34300-0.33	0.33 ± 10%	445	1
34300-0.47	0.47 ± 10%	375	2
34300-0.5	0.5 ± 10%	350	2
34300-0.68	0.68 ± 10%	300	2
34300-0.82	0.82 ± 10%	265	2
34300-1	1 ± 10%	175	4
34300-1.1	1.1 ± 10%	210	4
34300-1.2	1.2 ± 10%	210	3
34300-1.5	1.5 ± 5%	190	3
34300-1.8	1.8 ± 5%	171	3
34300-2.2	2.2 ± 5%	160	3
34300-2.5	2.5 ± 5%	140	3
34300-2.7	2.7 ± 5%	142	3
34300-3	3 ± 5%	132	3
34300-3.3	3.3 ± 5%	120	3
34300-3.9	3.9 ± 5%	118	3
34300-4.7	4.7 ± 5%	105	3
34300-5	5 ± 5%	85	3
34300-5.6	5.6 ± 5%	98	3
34300-6.2	6.2 ± 5%	90	7
34300-6.8	6.8 ± 5%	90	3
34300-8.2	8.2 ± 5%	81	3
34300-10	10 ± 5%	65	7

Catalog Number	Inductance Microhenries	Self Resonant Freq. Mc.	Fig. No.
34300-12	12 ± 5%	65	3
34300-15	15 ± 5%	22	8
34300-18	18 ± 5%	22	8
34300-20	20 ± 5%	27	8
34300-22	22 ± 5%	46	9
34300-24	24 ± 5%	24	8
34300-25	25 ± 5%	26	8
34300-27	27 ± 5%	23	8
34300-30	30 ± 5%	15	8
34300-33	33 ± 5%	36	9
34300-36	36 ± 5%	35	9
34300-39	39 ± 5%	18	8
34300-47	47 ± 5%	18	8
34300-50	50 ± 5%	18	8
34300-56	56 ± 5%	28	9
34300-68	68 ± 5%	26	9
34300-75	75 ± 5%	12	8
34300-100	100 ± 5%	13	8
34300-120	120 ± 5%	12	8
34300-150	150 ± 5%	11	8
34300-180	180 ± 5%	9.8	8
34300-200	200 ± 5%	7.5	8
34300-220	220 ± 5%	12	11
34300-250	250 ± 5%	6.8	8
34300-270	270 ± 5%	11.9	11
34300-300	300 ± 5%	6	8
34300-330	330 ± 5%	8.5	17
34300-350	350 ± 5%	8	12
34300-470	470 ± 5%	7.6	13
34300-500	500 ± 5%	7.5	13
34300-750	750 ± 5%	5.8	14
34300-820	820 ± 5%	5.7	13
34300-1000	1000 ± 5%	4	12
34300-1200	1200 ± 5%	4.8	15
34300-1800	1800 ± 5%	2.6	16
34300-2200	2200 ± 5%	2.8	18
34300-2500	2500 ± 5%	2.7	18
34300-10000	10000 ± 5%	1.5	18

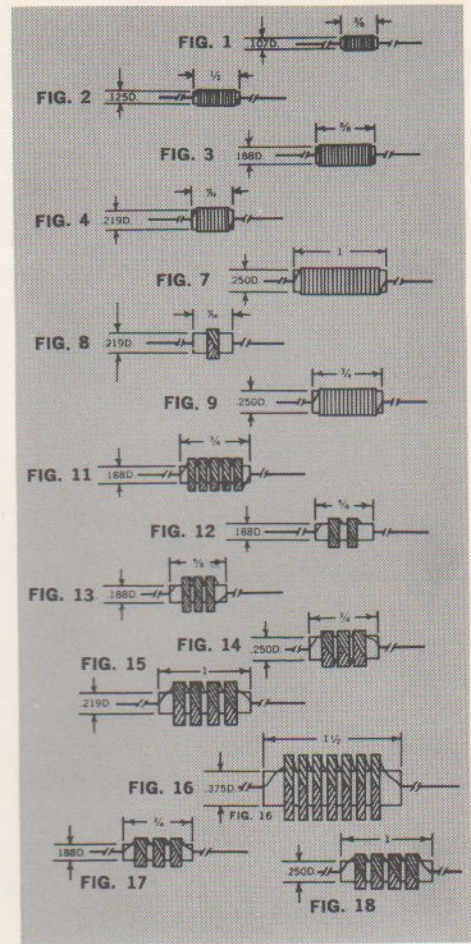

TRANSMITTING R-F CHOKES

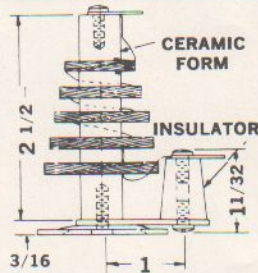
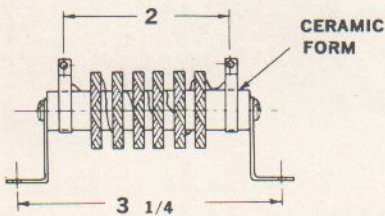

No. 34140 No. 34156 No. 34152 No. 34154

INDUCTANCE:	1.4	2.5	4.0	1.0	millihenries
RESISTANCE:	6.25	10.6	13.5	5.5	ohms
DC CURRENT:	500	500	500	600	milliamperes
VOLTAGE RATING:	4500	4500	8000	8000	VDC

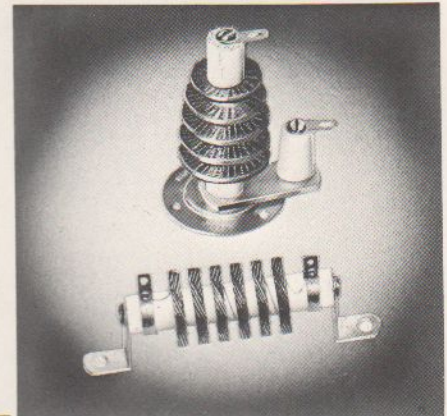

34100 SERIES R-F CHOKE COILS

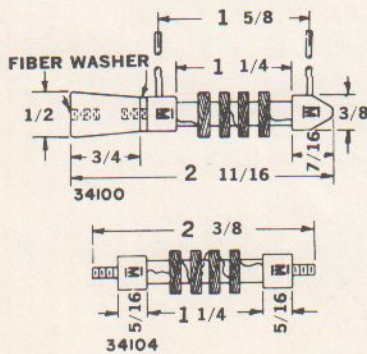

Ceramic forms and insulators. Leads: #18 tinned solid wire, 2 1/8" long. Mounting screws, 6-32 threaded x 1/4" long.

Catalog Number	Inductance Millihenries	Maximum Current
34100	2.5	250 MA.
34101	2.5	250 MA.
34102	2.5	250 MA.
34103	2.5	250 MA.
34104	2.5	250 MA.
34105	1.0	300 MA.
34106	1.0	300 MA.
34107	1.0	300 MA.
34108	1.0	300 MA.
34109	1.0	300 MA.

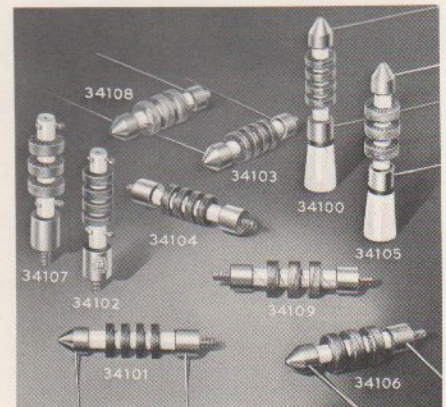



AIR WOUND TRANSMITTING INDUCTORS

43000 SERIES — 120 WATT COILS

43011	0.75	28	Fixed	Center	1	1-1/2	4	16
43012	0.75	28	Fixed	End	1	1-1/2	4	16
43015	1.35	21	Fixed	Center	1-3/16	1-1/2	6	16
43021	2.1	14	Fixed	Center	1-1/2	1-1/2	8	16
43022	2.5	14	Fixed	End	1-1/2	1-1/2	9	16
43041	11	7	Fixed	Center	2	1-1/2	22	16
43081	32	3.5	Fixed	Center	2	1-1/2	38	20
43082	36.2	3.5	Fixed	End	2	1-1/2	40	20
43115	1.9	21	Fixed	End	1-1/8	1-1/2	7	16
43162	57	1.8	Fixed	End	1-7/8	1-1/2	51	22

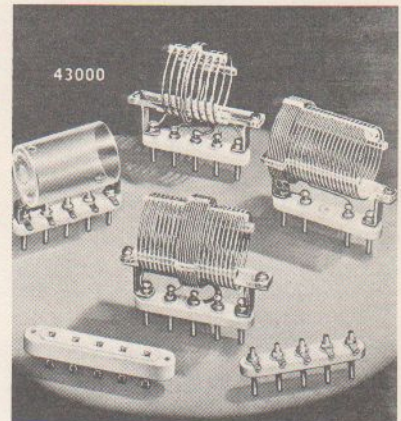

44000 SERIES — 150 WATT COILS

44005	0.81	50	Variable	Center	1-3/4	1-25/32	4	1/8 tube
44010	1.3	28	Variable	Center	2-1/8	1-13/16	6	1/8 tube
44015	2.4	21	Variable	Center	2-1/8	2-5/8	6	12
44040	15	7	Variable	Center	2-5/8	2-5/8	18	14
44080	49.4	3.5	Variable	Center	2-3/4	2-5/8	32	16
44160	54	1.8	Variable	Center	2-13/16	2-5/8	36	18

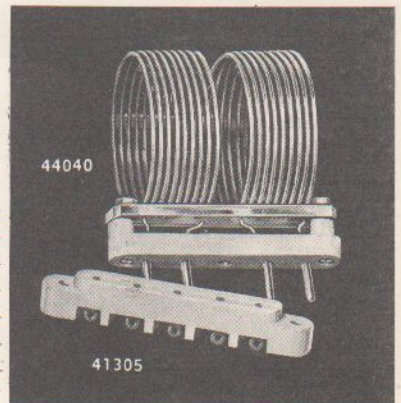

48000 SERIES — 120 WATT VHF COILS

48002	0.083	144	Fixed	Center	2	1/2	2	5/16" ribbon
48006	0.68	50	Fixed	Center	3/4	7/8	6	14
48011	2.6	28	Fixed	Center	7/8	27/32	12	16
48015	4.9	21	Fixed	Center	1-3/8	1-1/32	17	16
48021	15.4	14	Fixed	Center	1-9/16	1-1/32	26	16
48102	0.119	144	Variable	Center	1-1/16	1-3/32	2	1/8 tube
48106	1.35	50	Variable	Center	2-3/4	1-1/16	12	1/8 tube
48111	3.75	28	Variable	Center	2-1/4	7/8	22	16
48115	7.9	21	Variable	Center	2-5/8	1-1/16	26	16
48121	15.0	14	Variable	Center	2-7/16	1-1/16	38	18

No. 40205 — 5-PRONG COIL PLUG
Ceramic base. Pins brass nickel plated.
2500 VDC rating. Midget size. Fits
41205 socket.

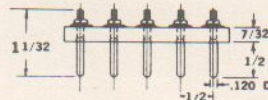

No. 41205 — 5-JACK COIL SOCKET
Ceramic base. Lugs phosphor bronze
silver plated. 2500 VDC rating.
Midget size. Fits 40205 plug.

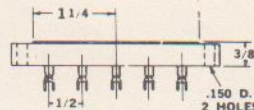

No. 40305 — 5-PRONG COIL PLUG
Molded base. Pins brass nickel plated.
4200 VDC rating. Intermediate size. Fits
41305 socket.

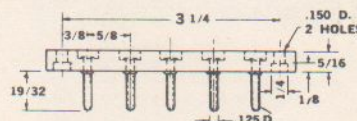

No. 41305 — 5-JACK COIL SOCKET
Ceramic base. Lugs phosphor bronze
silver plated. 4200 VDC rating. Inter-
mediate size. Fits 40305 plug.

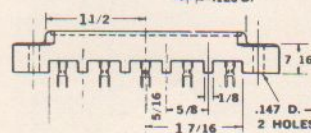

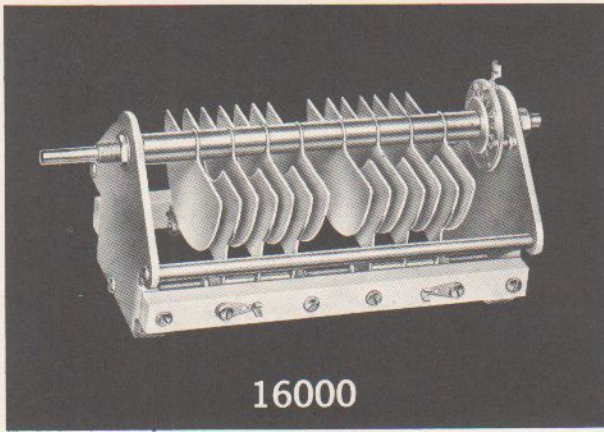

16000

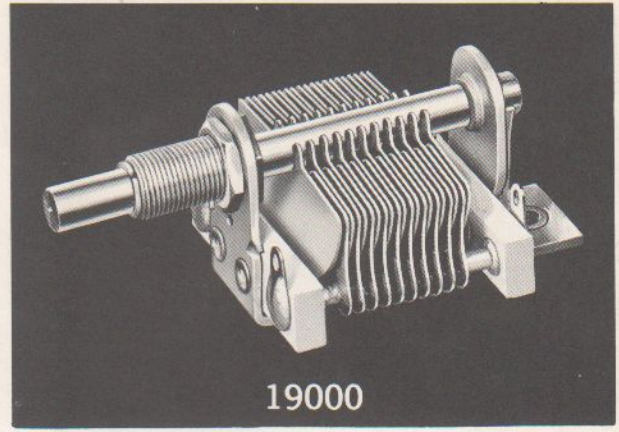
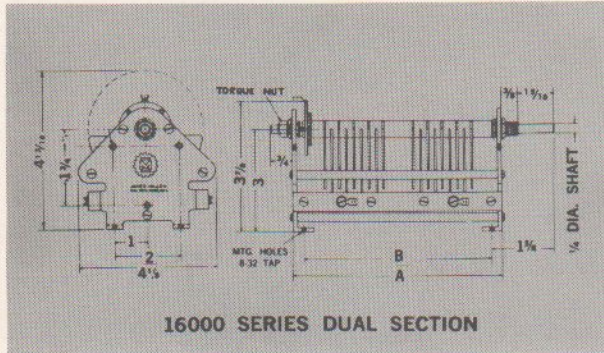

19000

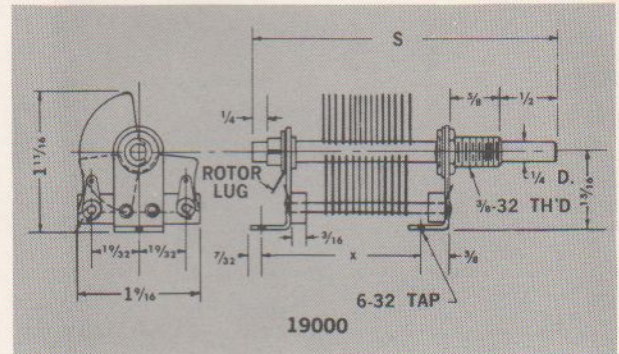

16000 SERIES TRANSMITTING CAPACITORS

FEATURES: The 16000 Series has sturdy construction, thick, round-edged, polished aluminum plates with 1 3/4" radius. Also has constant impedance, heavy current, multiple finger rotor contactor of unique design. Available in single and double sections and many capacities and plate spacings. Other features: aluminum frame, Grade L423 ceramic bars, brass hardware, nickel-plating.

SINGLE SECTION — 0.171" AIR GAP — 6000 V. PEAK

Millen Cat. No.	Capacity MMF	Dimension "A"	Dimension "B"	Plates Per Sec.
16550	13. - 52	3 3/8"	2 3/4"	5R- 4S
16510	17. -101	6 1/4"	5 5/8"	9R- 8S
16520	37. -203	9 1/2"	8 7/8"	18R-16S
16530	45. -297	12 1/2"	11 7/8"	25R-24S

SINGLE SECTION — 0.265" AIR GAP — 9000 V. PEAK

16559	11. - 65	6 1/4"	5 5/8"	8R- 7S
16512	40. -128	11 1/2"	10 7/8"	16R-14S

DOUBLE SECTION — 0.077" AIR GAP — 3000 V. PEAK

16200	15. -195	6 1/4"	5 5/8"	8R- 8S
16250	20. -255	9 1/2"	8 7/8"	10R-10S

DOUBLE SECTION — 0.171" AIR GAP — 6000 V. PEAK

16030	8.5- 27	4 1/4"	3 5/8"	3R- 2S
16050	12. - 51	6 1/4"	5 5/8"	5R- 4S
16100	19. -101	9 1/2"	8 7/8"	9R- 8S

DOUBLE SECTION — 0.265" AIR GAP — 9000 V. PEAK

16029	11. - 29	6 1/4"	5 5/8"	4R- 3S
16059	20. - 64	11 1/2"	10 7/8"	8R- 7S

19000 SERIES TUNING CAPACITORS

FEATURES: The 19000 Series is a versatile single section tuning capacitor to meet special requirements available below. Threaded brass front bearing and tapped end brackets permit panel or base mounting. This series has Grade L423 ceramic insulators, soldered brass rotors and stators; rotor shaft supported on bearings at both front and rear of capacitor. Brass plates are nickel-plated.

MODEL SPECIFICATIONS: Straight line capacity characteristic. Single spaced types have 0.022" air gap — 850 V. peak. The 19000 Series may be supplied with wide air gaps. Specify type number followed by the designation of W or Y. Air gap: (W) 0.040" — 1350 V. peak; (Y) 0.066" — 2250 V. peak.

19000 SERIES — 0.022" AIR GAP — 850 V. PEAK

Millen Cat. No.	Max. Cap.	Min. Cap.	Rotor Plates	Stator Plates	Dim. "S"	Dim. "X"
19025	30.5 mmf	5.7 mmf	2	2	2 5/8"	7/8"
19035	39.1 mmf	6.0 mmf	3	2	2 5/8"	7/8"
19050	58.0 mmf	6.5 mmf	4	3	2 13/16"	1"
19075	80.5 mmf	7.5 mmf	5	5	2 7/8"	1 1/8"
19100	107.0 mmf	8.2 mmf	7	6	3"	1 1/4"
19140	148.0 mmf	9.7 mmf	9	9	3 1/16"	1 3/8"
19200	232.5 mmf	11.7 mmf	14	13	3 1/2"	1 3/4"
19250	272.5 mmf	13.0 mmf	17	16	3 3/4"	2"
19280	285.3 mmf	20.0 mmf	18	17	3 3/4"	2 1/16"
19335	339.0 mmf	14.7 mmf	21	20	4 1/8"	2 3/8"

19000 SERIES — 0.066" AIR GAP — 2250 V. PEAK

19935	40.0 mmf	8.8 mmf	6	6	3 5/8"	1 3/4"
19950	60.0 mmf	11.6 mmf	9	9	4"	2 1/4"

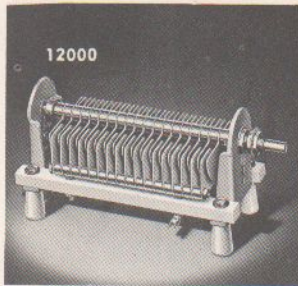

12000

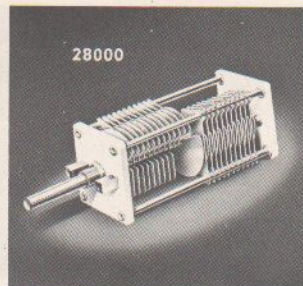

28000

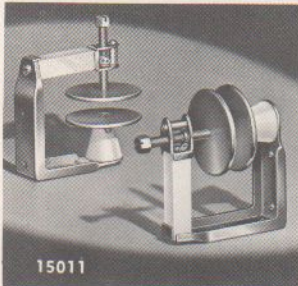

15011

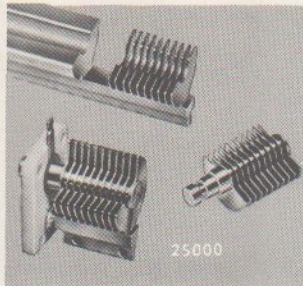

25000

12000 SERIES TRANSMITTING CAPACITORS — Rigid heavy channeled aluminum end plates. Ceramic insulation, polished or plain edges. One piece rotor contact spring and connection lug. Compact, easy to mount with connector lugs in convenient locations. Available in single and double sections and many capacities and plate spacings.

28000 SERIES VARIABLE AIR CAPACITORS — "Designed for Application," double bearings, steatite end plates, plated brass plates. Single or double section .022" to .066" air gap. End plate size: $1\frac{1}{16}$ " x $1\frac{1}{16}$ ". Rotor plate radius: $\frac{3}{4}$ ". Shaft lock, rear shaft extension, special mounting brackets, etc., to meet your requirements. The 28000 series has semi-circular rotor plate shape. Many stock sizes.

NEUTRALIZING CAPACITOR — Designed originally for use in our own Power Amplifier, the No. 15011 disc neutralizing capacitor has such unique features as rigid channel frame, horizontal or vertical mounting, fine thread oversize lead screw with stop to prevent shorting and rotor lock. Heavy rounded-edged polished aluminum plates are 2" diameter. Glazed steatite insulation.
No. 15011

NO. 25000 SERIES MACHINED FROM SOLID BARS OF EXTRUDED BRASS — Modern demands for miniature precision, high Q variable air dielectric capacitors with high reliability require that all of the stator plates be machined from a solid block of brass and that all of the rotor plates be machined from a solid block of brass.

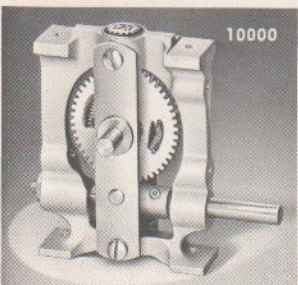

10000

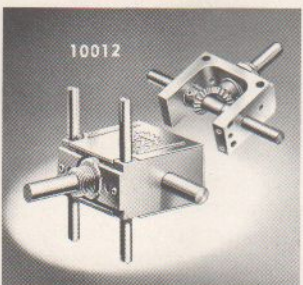

10012

WORM DRIVE UNIT — Cast aluminum frame may be panel or base mounted. Spring loaded split gears to minimize back lash. Standard ratio 16/1. Also in 48/1, 36/1, 12/1.
No. 10000 — (state ratio)

RIGHT ANGLE DRIVE — Extremely compact, with provisions for many methods of mounting. Ideal for operating potentiometers, switches, etc., that must be located, for short leads, in remote parts of chassis.
No. 10012 For $\frac{1}{4}$ " shaft:



69057
69058
69051
69052
69045
69046
69043
69041
69042

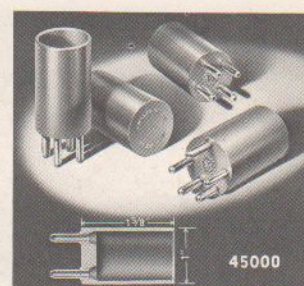

45000

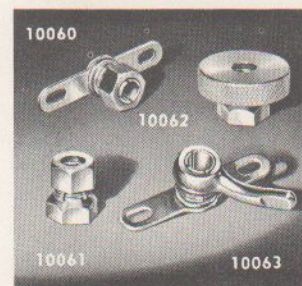

10060
10062
10061
10063



39024

10061

39023

PERMEABILITY TUNED CERAMIC FORMS — The 69000 series of ceramic permeability tuned unshielded forms are stock items. Winding diameters available from $\frac{1}{16}$ " to $\frac{1}{2}$ " and winding space from $\frac{1}{32}$ " to $1\frac{1}{2}$ ".
No. 69041—(Copper Slug)..... No. 69052—(Iron Core).....
No. 69042—(Iron Core)..... No. 69054—(Iron Core).....
No. 69044—(Brass Slug)..... No. 69055—(Copper Slug).....
No. 69045—(Copper Slug)..... No. 69056—(Iron Core).....
No. 69046—(Iron Core)..... No. 69057—(Copper Slug).....
No. 69047—(Copper Slug)..... No. 69058—(Iron Core).....
No. 69048—(Iron Core)..... No. 69061—(Copper Slug).....
No. 69051—(Copper Slug)..... No. 69062—(Iron Core).....

MILLEN COIL FORMS — Made of low loss mica filled brown bakelite. Guide funnel makes for easy threading of leads through pins.
No. 45000 — No pins No. 45004— 4 pins No. 45005— 5 pins

SHAFT LOCKS — In addition to No. 10060 and No. 10061 shaft locks, we can also furnish such variations as the No. 10062 and No. 10063 for easy thumb operation. The No. 10061 converts any plain " $\frac{1}{4}$ " shaft" control, condenser, etc. from "plain" to "shaft locked" type.

HIGH VOLTAGE INSULATED SHAFT EXTENSION — No. 10061 shaft locks and the No. 39023 insulated high voltage potentiometer extension mountings are available as a single integrated unit — the No. 39024. The standard shaft has provision for screw driver adjustment. Extension shaft and insulated coupling are molded as a single unit to provide accuracy of alignment.
No. 39023, non locking type .. No. 39024, locking type ..



75012

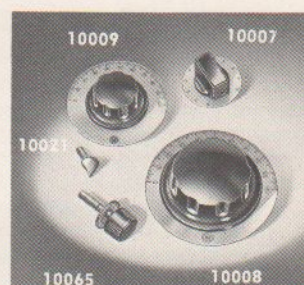

10009
10007
10021
10065
10008

PHASE-SHIFT NETWORK — A laboratory aligned pair of networks in a $2" \times 1\frac{1}{16}" \times 4"$ case with a phase shift between the two networks of $90^\circ \pm 1.3^\circ$ over a frequency range of 225 to 2750 cycles. For use in SSB transmitter or receiver. 40 db suppression of the unwanted sideband.
No. 75012

DIALS AND KNOBS — Just a few of the many stock types of small dials and knobs are illustrated herewith. 10007 is $1\frac{1}{8}$ " diameter, 10009 is $2\frac{3}{4}$ " and 10008 is $3\frac{1}{2}$ ".



TRANSMATCH

CONVERTS IMPEDANCE OF ANY 15 TO 500 OHM COAXIAL FED ANTENNA SYSTEM TO 50 OHMS



The No. 92200 Transmatch is a 2 KW band-switching, adjustable r.f. transformer with a reflectometer as the indicator. The Transmatch, inserted between a transmitter and a transmission line, will convert the impedance of any 15 to 500 ohm coaxial fed antenna system to 50 ohms so that the transmitter may, at all frequencies, work into the impedance for which it was designed.

Most transmitters have pi-network tank circuits designed to work into a 50 ohm load. If the actual transmitter load is other than 50 ohms the transmitter cannot be loaded properly for optimum operation.

Multi-band beam antennas or trap dipoles are fed with 50 ohm coaxial cable, however, no antenna designed to cover a band of frequencies will look like a pure resistance of 50 ohms across even a portion of the band. There will be a mismatch as frequency is changed within a band. The antenna height, proximity to nearby objects, and its impedance at resonance affect the match or mismatch between the antenna and the transmission line. The match or mismatch between the antenna and the transmission line determines the impedance the transmission line presents to the transmitter. When the antenna is not matched into the 50 ohm transmission line, the transmitter load will not be 50 ohms even though 50 ohm coaxial cable is used. This means the transmitter will not be working into 50 ohms and will not do the job for which it was designed. With the Transmatch this situation is corrected.

The Transmatch is a single-ended or unbalanced unit intended to match single-ended transmitters to coaxial transmission lines. It can match any antenna system between 15 and 500 ohms to a transmitter impedance of 50 to 70 ohms.

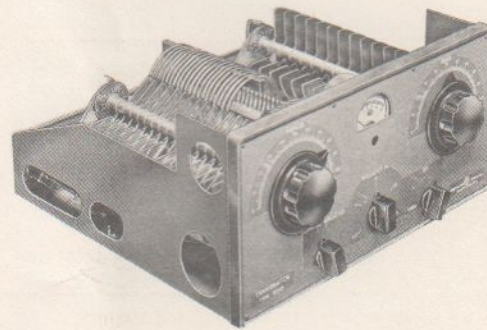

TECHNICAL SPECIFICATIONS

- Input impedance (transmitter)** 50 to 70 ohms single-ended.
- Output impedance (transmission line)** 15 to 500 ohms coaxial: 10 to 1000 ohms at most frequencies.
- Frequency range** — 3.5, 7, 14, 21, 28 MC amateur bands band-switched.
- Power handling capability** — 2 KW peak.
- Indicator** — 50 ohm Reflectometer using a 200 micro-ampere meter.
- Desk top cabinet size:** 7" H. x 14" W. x 13 $\frac{5}{8}$ " D.
- Weight:** 17 lbs.

At most frequencies the antenna system impedance may be as low as 10 ohms or as high as 1000 ohms and still the Transmatch will match it to the 50 ohm transmitter output. It also has provisions for coupling the No. 90932 Modulation Monitor to the transmitter output.



TRANSMATCH JUNIOR

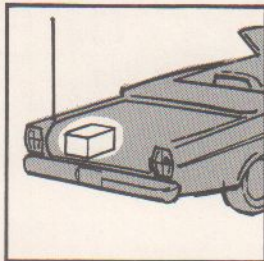
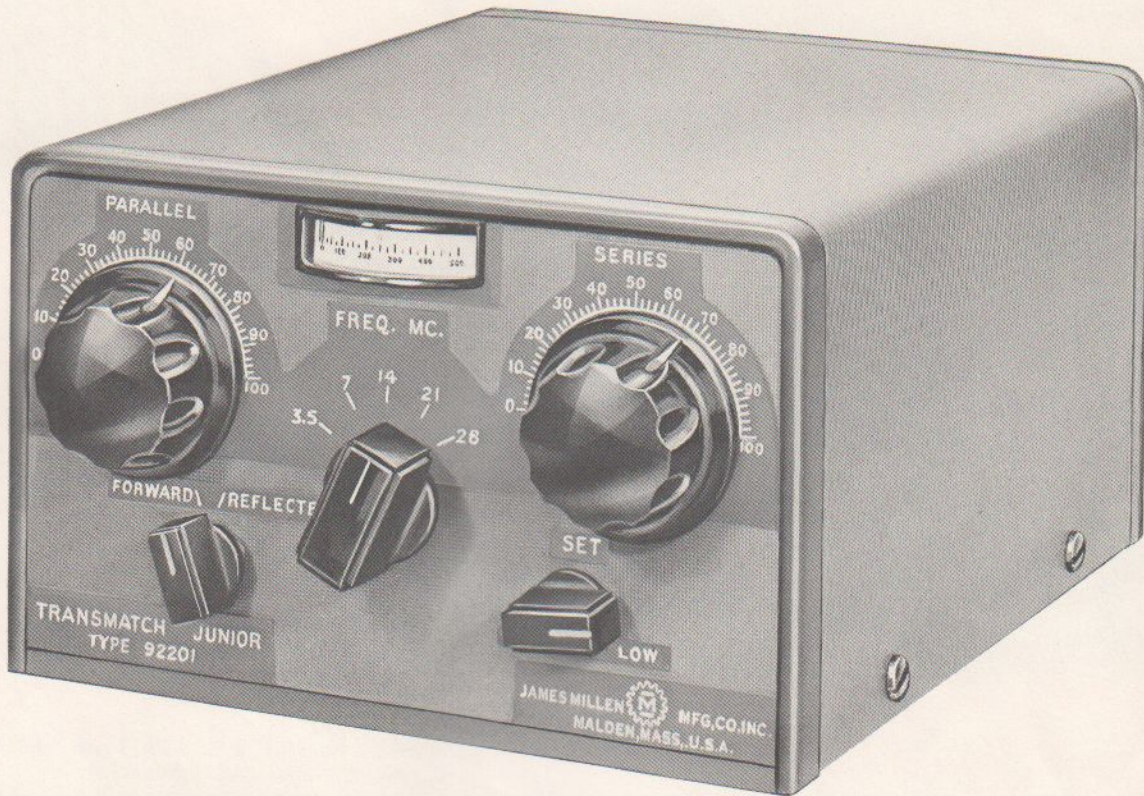

Small, lightweight for mobile use.

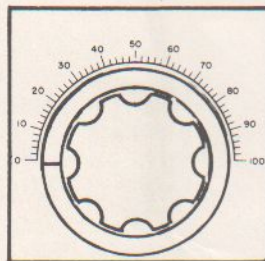

Graduated dials for fast resetting.

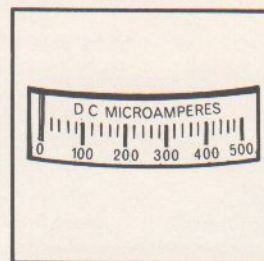

Built-in sensitive meter.



Easy installation (2 bolts)

The No. 92201 TRANSMATCH JUNIOR is a 300 watt band-switching r.f. transformer with a reflectometer as the indicator. The TRANSMATCH JUNIOR, inserted between a transmitter and a transmission line, will convert the impedance of any 10 to 500 ohm coaxial fed antenna system to 50 ohms so that the transmitter may, at all frequencies, work into the impedance for which it was designed.

Most transmitters are designed to work into a 50 ohm load and lose efficiency working into other than a 50 ohm load. The impedance of any antenna varies as the frequency varies within a band and this causes a mismatch between the antenna and the 50 ohm transmission line. With this mismatch the transmitter works into other than the intended 50 ohm load and therefore loses efficiency. The TRANSMATCH JUNIOR converts this and any other mismatch in the antenna system into a 50 ohm load so that the transmitter will be properly loaded and work at peak efficiency at all frequencies.

TECHNICAL SPECIFICATIONS

Input impedance (transmitter) 50 to 70 ohms single-ended.
Output impedance (transmission line) 10 to 500 ohms coaxial: 5 to 1000 ohms at most frequencies.
Frequency range — 3.5, 7, 14, 21, 28 MC. amateur bands band-switched.
Power handling capability — 300 watts peak.
Indicator — 50 ohm reflectometer using a 500 microampere meter.
Cabinet size: 7" W. x 4³/₄" H. x 9" D. (including knobs)
Weight: 6 lbs.

The TRANSMATCH JUNIOR is a lower power, lower cost, version of the No. 92200 2 KW TRANSMATCH. It is small and lightweight and therefore ideal for mobile use as well as for stationary use.

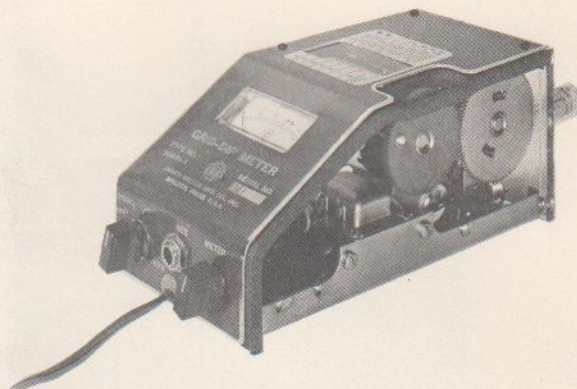

"Designed for Performance"®

NO. 90651-A GRID DIP METER

The Millen No. 90651-A Grid Dip Meter features a transistor d.c. amplifier, and taut band meter.

The No. 90651-A has a transistor d.c. amplifier to increase sensitivity. It provides full scale meter reading at all frequencies from 1.7 to 300 mc. It has a modern, taut band meter to eliminate any possibility of the meter ever becoming "sticky." These additions are made while still maintaining all of the features which have made the Millen No. 90651 Grid Dip Meter so thoroughly reliable it has become the standard of the industry. It uses the same stable oscillator without spurious dips, it has a transformer-type power supply, it has seven coils protected by form fitting molded covers, etc.

The No. 90651-A is supplied complete in a convenient polypropylene carrying case which keeps the coil/probes with the Grid Dip Meter and protects both.

Five additional coils are available for extending the range to 165 KC.

The Millen 90651-A Grid Dip Meter is a calibrated stable RF oscillator unit with a transistorized electronic voltmeter to indicate the amplitude of the output. The frequency determining coil is plugged into the unit so that it may be used as a probe.

There is a set of terminals on the internal printed circuit board to provide connections for battery operation where it is desirable to use the unit on antenna measurements and other applications where A.C. power is not available. Compactness has been maintained with improvement in performance and convenience of use while still keeping the unusual ease of reading the dial accurately.

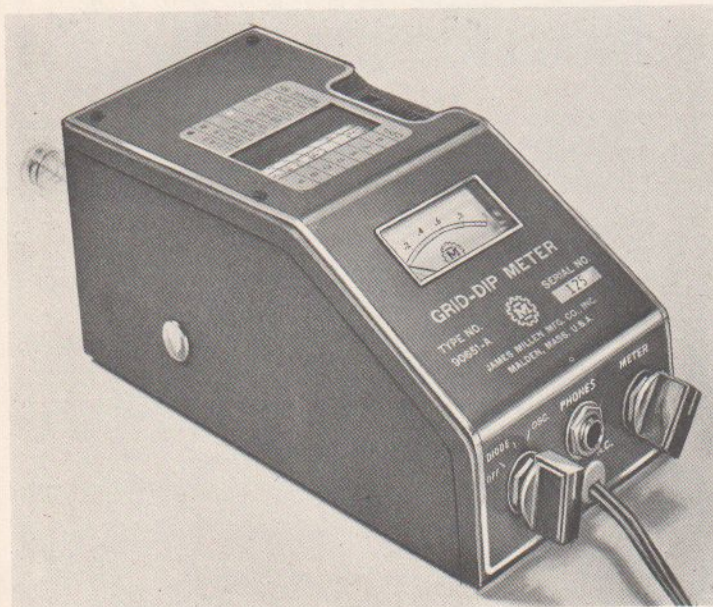

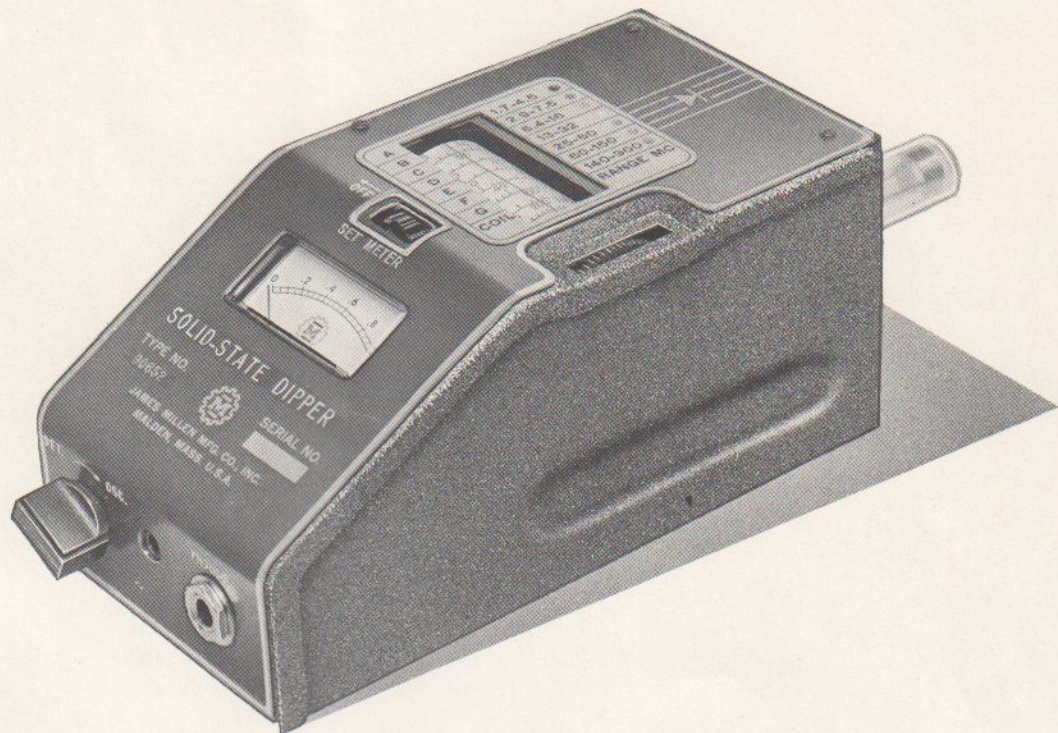

SOLID-STATE DIPPER

The Millen No. 90652 Solid-State Dipper introduces a new dip oscillator with performance comparable to that of the best vacuum-tube grid dip meters previously available, but with the universal advantage of battery power which eliminates the power cord and provides a portability which is not restricted by the requirement for a-c power.

The operating features of the No. 90652 Solid-State Dipper include (1) a sensitive oscillator-dipper for checking resonant frequencies of non-energized resonant circuits, and (2) an absorption-type wavemeter with the oscillator circuit arranged to act as a Q-Multiplier Amplifier, providing both a sharp tuning response and great sensitivity. The frequency range of 1.7 to 300 Mc/s is covered by 7 plug-in coils, with some overlap between ranges. The lowest frequency coil (1.7 to 4.0 Mc/s) is wound on a powdered-iron core to increase Q and improve coupling to circuits being checked.

The circuit of the No. 90652 Solid-State Dipper is reliable and straight-forward, making use of standard semi-conductor elements. The oscillator is a 3N128 MOS-FET in a Colpitts circuit. The r-f voltage across the tank circuit is rectified by 2-1N3604 diodes in a full-wave connection to develop a d-c voltage proportional to the r-f present in the coil. This d-c voltage is indicated by means of a JFET (2N5459) d-c amplifier on a rugged 1 ma. full-scale meter using a taut-band suspension. A suppressed-zero

system is used to enhance the sensitivity of the dip indication. Provision is made for the use of headphones to aid in detecting beats and in listening to any modulation which may be present on a signal. The meter-setting potentiometer incorporates an easily visible indicator to show whether the battery switch is ON or OFF.

The performance of the Millen No. 90652 Solid-State Dipper is equal to or superior to that of the previous standards of the industry, the Millen No. 90651-A and No. 90662-A Grid Dip Meters. In addition, it offers the convenience of self-contained battery power for complete portability.

The No. 90652 Solid-State Dipper is supplied in a convenient polypropylene carrying case with a complete set of coils and a 9-volt alkaline battery to provide instant operation. A $\frac{1}{4}$ "-20 tapped socket hole is provided for attachment of a wrist strap, or other retaining device to prevent dropping the dipper when using it in hazardous locations, such as on antenna masts for checking beam antennas.

Size of Dipper — $7\frac{1}{4}$ "L x $3\frac{1}{2}$ "W x $3\frac{3}{16}$ "H

Weight of Dipper — $2\frac{1}{2}$ Pounds with battery

Size of Carrying Case With Dipper and Coils —

$11\frac{3}{8}$ "L x $5\frac{1}{8}$ "W x 4"H

Shipping Weight — 7 Pounds

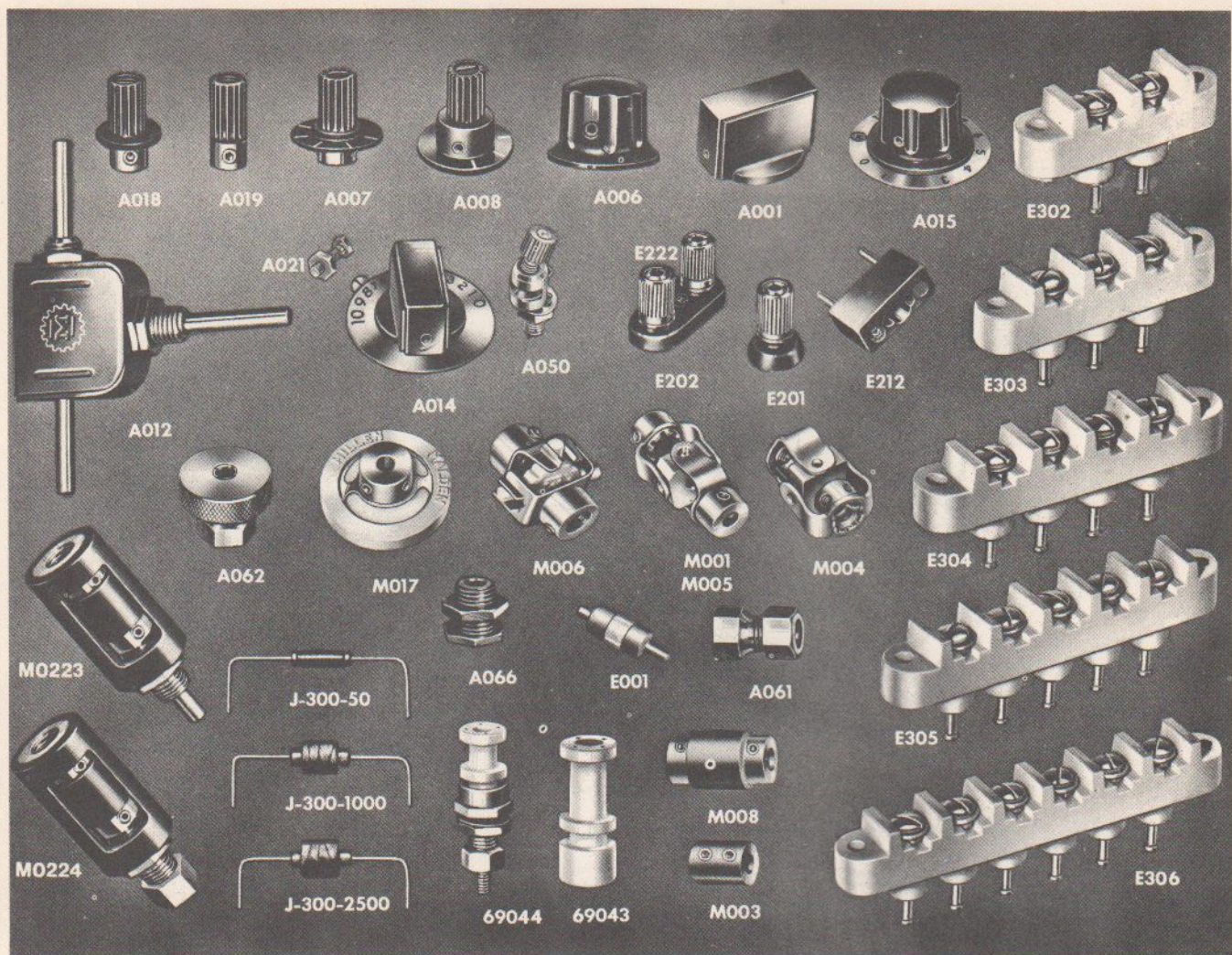

MINIATURIZED COMPONENTS

DESIGNED for APPLICATION miniaturized components developed for use in our own equipment such as the 90901 Oscilloscope, are available for separate sale. Many of these parts are similar, in most details except size, to their equivalents in our standard component parts group. In certain devices where complete miniaturization is not paramount, a combination of standard and miniature components may possibly be used to advantage. For convenience, we have also listed on this page the extremely small sized coil forms from our standard catalog.

Code	Description
A001	Bar knob for $\frac{1}{8}$ " shaft. $\frac{1}{2}$ " high by $\frac{3}{4}$ " long.
A006	Fluted black plastic knob with brass insert for $\frac{1}{8}$ " shaft. $\frac{1}{2}$ " high by $\frac{3}{4}$ " diameter.
A007	$\frac{1}{4}$ " black plastic dial knob with brass insert for $\frac{1}{8}$ " shaft. $\frac{5}{8}$ " diameter dial. $\frac{1}{16}$ " high.
A008	$\frac{1}{4}$ " black plastic knob. Same as no. A007 except for style.
A012	Right angle drive for $\frac{1}{8}$ " shafts. Single hole mounting.
A014	1" bar dial for $\frac{1}{8}$ " shaft. $\frac{1}{2}$ " high. 180° or 280° dials for clockwise or counter-clockwise rotation.
A015	1" fluted knob dial for $\frac{1}{8}$ " shaft. $\frac{1}{2}$ " high. Same dial plates as no. A014.
A017	$1\frac{1}{8}$ " diameter fluted black plastic knob for $\frac{1}{8}$ " shaft.
A018	Knob, same as no. A007 except with $\frac{7}{16}$ " diameter flange.
A019	Knob, same as no. A007, but without dial.
A021	Miniature metal index for miniature dials.
A050	Miniature dial lock.
A061	Shaft lock for $\frac{1}{8}$ " diameter shaft. $\frac{1}{4}$ "-32 bushing. Nickel plated brass.
A062	Shaft lock with knurled locking nut.

Code	Description
A066	Shaft bearing for $\frac{1}{8}$ " diameter shafts. Nickel plated brass. Fits $\frac{1}{4}$ " diameter hole.
E001	Steatite ceramic standoff or tie-point. Integral mounting eyelet. 0.205" overall diameter.
E201	Black or red plastic binding post plates for No. E222.
E202	Black or red plastic plates for two binding posts spaced $\frac{1}{2}$ ".
E212	Black or red plastic plug for two binding posts spaced $\frac{1}{2}$ ".
E222	Metal binding post with jack top.
E302A	Steatite ceramic terminal strips. $\frac{5}{16}$ " wide. Terminals spaced $\frac{3}{8}$ " on centers. Screw type or solder type thru-terminals.
J300-3.3	to J300-2500 Complete line of miniature inductances 3.3 to 2500 microhenries. $\frac{3}{8}$ " long. Diameter 0.115" to 0.313".
M001	Insulated universal joint style flexible coupling for $\frac{1}{8}$ " dia. shafts.
M003	Solid coupling for $\frac{1}{8}$ " dia. shafts. Nickel plated brass.
M004	Universal joint style flexible coupling for $\frac{1}{8}$ " diameter shafts. Inverted hubs for short length. Not insulated.
M005	Universal joint style flexible coupling for $\frac{1}{8}$ " diameter shafts. External hub. Not insulated.
M006	Universal joint style flexible coupling for $\frac{1}{8}$ " diameter shafts. Spring finger. Steatite ceramic insulation.
M008	Plastic insulated coupling with nickel plated brass inserts for $\frac{1}{8}$ " diameter shafts.
M017	Plastic insulated flexible coupling for $\frac{1}{8}$ " diameter shafts. $\frac{1}{32}$ " long by $\frac{1}{16}$ " diameter. Bronze yoke.
M023	Insulated shaft extension for $\frac{1}{4}$ "-32 bushing and $\frac{1}{8}$ " shaft. For mounting sub-miniature potentiometer.
M024	Locking insulated shaft extension similar to no. M023.
69044	Steatite ceramic coil form. Adjustable core. Winding space 0.187" dia. by $\frac{1}{16}$ " long. No. 10-32 mounting.